



MDS

LED DISPLAYS

LED Displays in virtually any Size to fit your requirements



www.MDSdisplays.com
sales@mdsdisplays.com



Brilliant LED Displays, in virtually any size or application - to fit your requirements.

INDOOR FIX Installation LED SCREEN



ULTRA THIN DESIGN

Available pixel pitch:
P1.25/P1.56/P1.8/P2.5

LED type: SMD or GOB

LED panel size:
600x337.5mm (27 inch)

Maintenance: Front

Installation: Front or rear

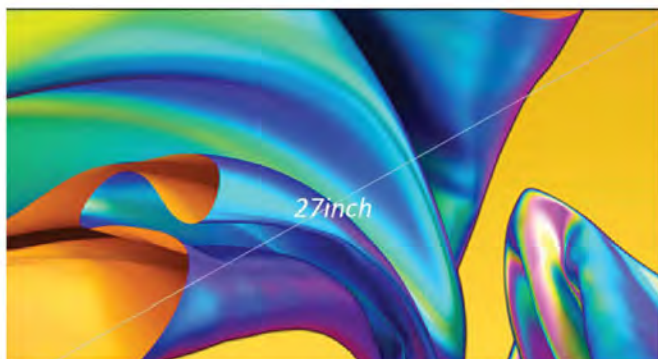

Wall Mounted

Stacking Installation

Hanging Installation



Brilliant LED Displays, in virtually any size or application - to fit your requirements.

IN- OUTDOOR RX RENTAL LED SCREEN



HIGH PRECISION DESIGN

INDOOR Available pixel pitch:
P1.9/P2.6/P3.1/P3.91

OUTDOOR Available pixel pitch:
P2.6/P3.91/P4.81

LED Panel size:
500x500 / 500x1000mm

Installation: Concave & Convex



Stacking Installation



Hanging Installation



Brilliant LED Displays, in virtually any size or application - to fit your requirements.

IN- OUTDOOR RENTAL LED SCREEN



HIGH PERCISION DESIGN

INDOOR Available pixel pitch:
P2.6/P2.9/P3.91

OUTDOOR Available pixel pitch:
P3.91/P4.81

LED Panel size:
500x500 / 500x1000mm

Installation: Rear

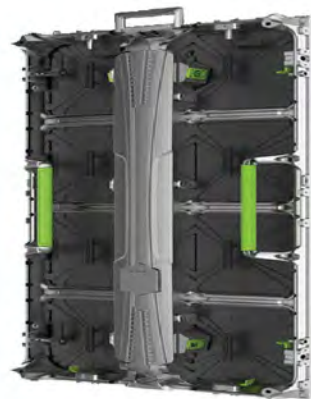

Stacking Installation



Hanging Installation

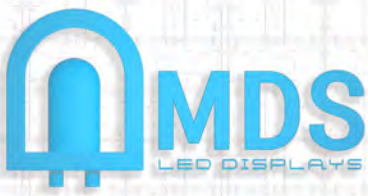

Brilliant LED Displays, in virtually any size or application - to fit your requirements.

OUTDOOR FIXED Billboard Energy Saving



ENERGY SAVING

Available pixel pitch:
P4.16/P5.0/P6.25/P8.33/P10
LED Panel size: 800(w)x1200mm
800(w)x900(h)mm
Maintenance: Front or Rear
Special: Power Saving
Curved possible





Brilliant LED Displays, in virtually any size or application - to fit your requirements.

TRANSPARENT IN- OUTDOOR RENTAL SCREEN



HIGH TRANSPARENCY

Available pixel pitch:
P2.8-P5.6/P3.91-7.81

LED Panel size:
1000(w)x500(h)mm

Installation: Indoor & Outdoor
Variants



Outdoor variant

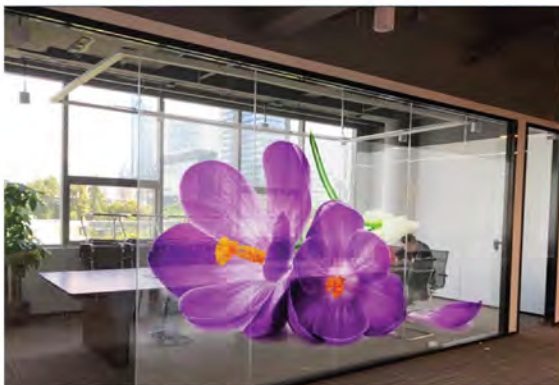

Stacking Installation



Hanging Installation

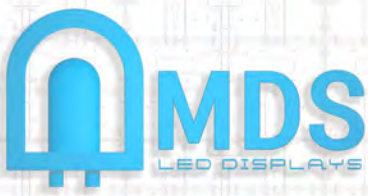

Brilliant LED Displays, in virtually any size or application - to fit your requirements.

OUTDOOR STADIUM LED DISPLAY



ROBUST + SAFE DESIGN

Available pixel pitch:
P8.0

Brightness: 7000cd/m2

LED Panel size:
1280x960 / 960x960mm

Safety: Foam Protector

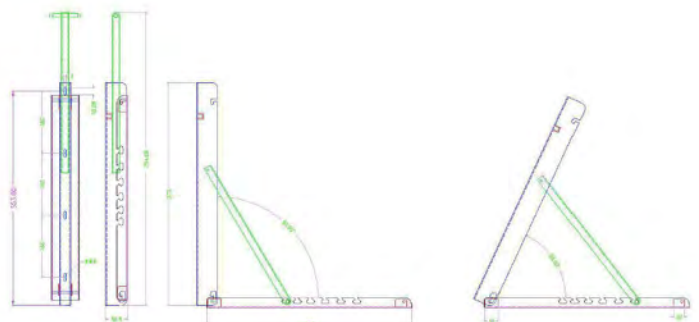
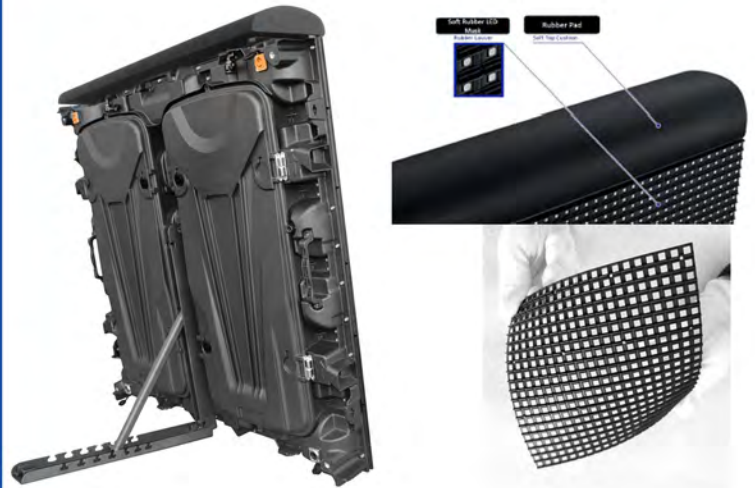

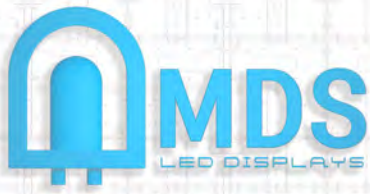

Brilliant LED Displays, in virtually any size or application - to fit your requirements.

TRANSPARENT LED FILM CUSTOMIZABLE



HIGH TRANSPARENCY

Available pixel pitch:
P10

LED Panel size:
960(w)x320(h)mm

Installation: Indoor - Easy
installation: Screens attach
directly to the window-glass





Brilliant LED Displays, in virtually any size or application - to fit your requirements.

INDOOR GOB WALL MOUNTED LED WALL



GOB TECHNOLOGY

Available pixel pitch:
P1.8/P2.0/P2.5

LED Panel size:
640(w)x480(h)mm

Installation: Indoor
Front or Rear
Maintenance from front
GOB and SMD Optional

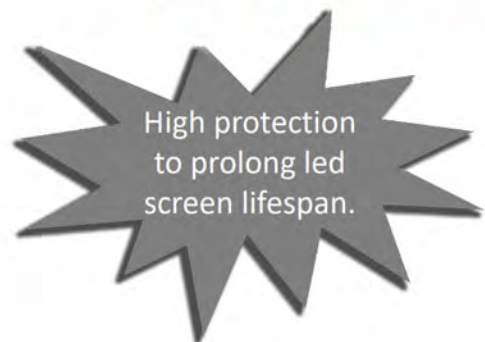
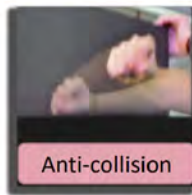
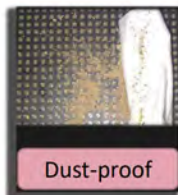



Brilliant LED Displays, in virtually any size or application - to fit your requirements.

FLEXIBLE CREATIVE CUSTOM SCREEN



HIGH FLEXIBILITY

Available pixel pitch: P1.5/P1.6
P1.86/P2.0/P2.5/P3.0/P4.0

OUTDOOR Available pixel pitch:
P3.91/P4.81

LED Module size:
240x120mm / 320x160mm

Installation: Rear





Brilliant LED Displays, in virtually any size or application - to fit your requirements.

INDOOR POSTER Floor standing LED Poster

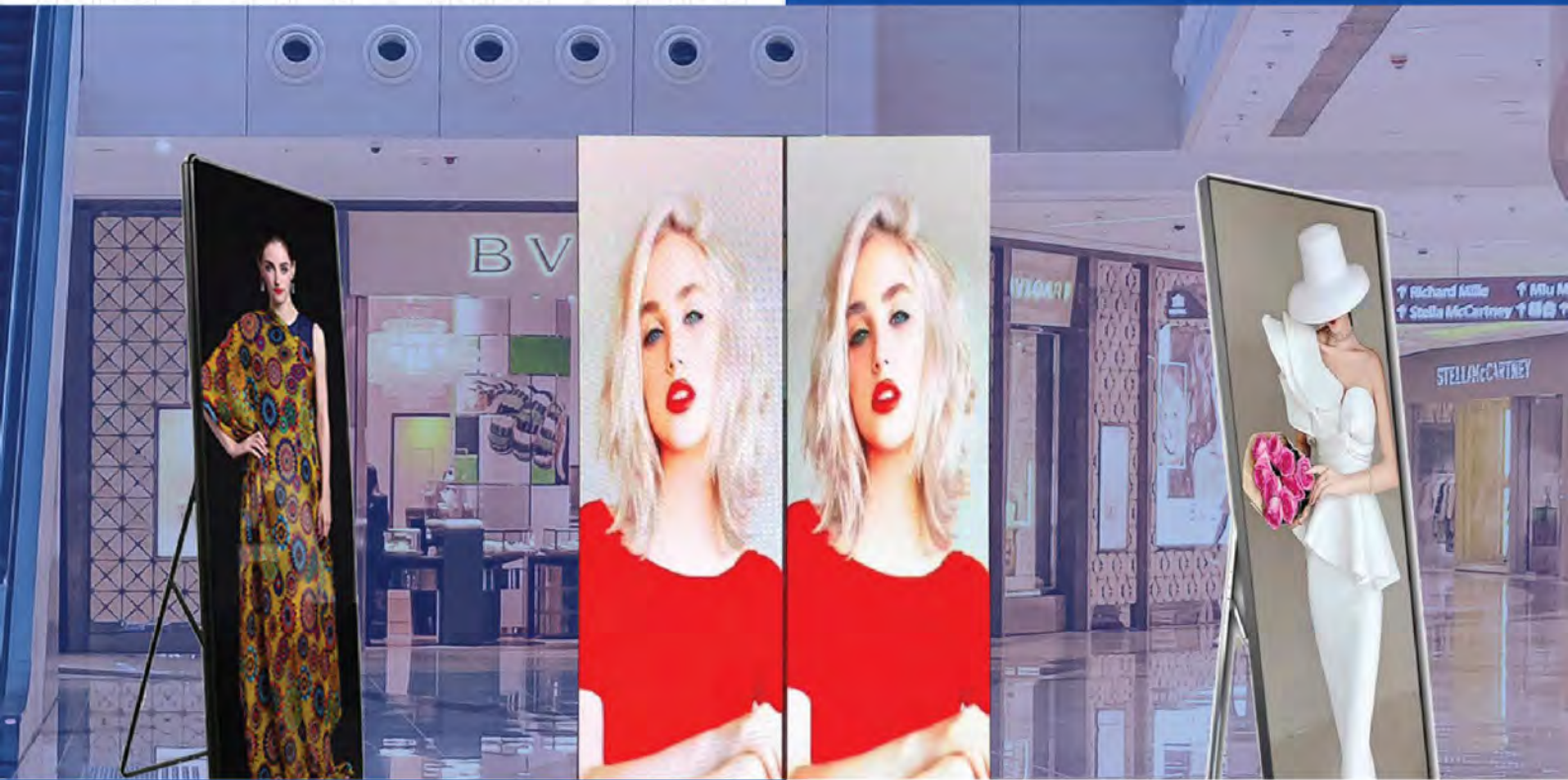

SMART CONTROL

Available pixel pitch:
P1.8/P2.0/P2.5

LED Panel size:
640(w)x1920(h)mm

Usage: Indoor Retail, Stage,
Store, Studio

Supports:
USB/WiFi/HDMI/Cloudservice





Brilliant LED Displays, in virtually any size or application - to fit your requirements.

SMART All in One LED TV SCREEN



Smart Wireless Projection

Available pixel pitch:
P1.25 COB/P1.56 COB
Screen Size: 108",135",162"
Installation: Wall mounted
or Movable on wheels
Wireless Projection: Mobile,
iPad, PC, 4 PIP dividable



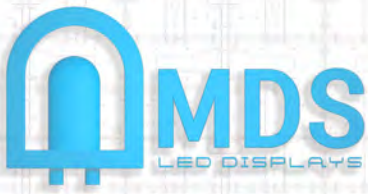

Brilliant LED Displays, in virtually any size or application - to fit your requirements.

DANCE FLOOR In- and Outdoor Interactive



ENERGY SAVING

Available pixel pitch:
P2.9/P3.91

LED Panel size:
500(w)x1000(h)mm

Usage: Indoor & Outdoor

Maintenance: Front

Load capacity: 2.5 Tons



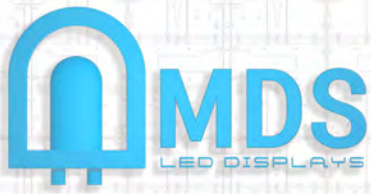

Brilliant LED Displays, in virtually any size or application - to fit your requirements.

OUTDOOR 3D Curved 3D Wall Energy Saving



ENERGY SAVING

Curved Angle





Brilliant LED Displays, in virtually any size or application - to fit your requirements.

SMART SHELF LED Shelf Signage



SMART CONTROL

Available pixel pitch:
P1.25 COB/P1.87

LED Panel size:
300(w)x60(h)mm

Usage: Retail, Stage, Store
Ultra HD, Anti-Collision Design

Supports:
USB/WiFi/HDMI/Cloudservice

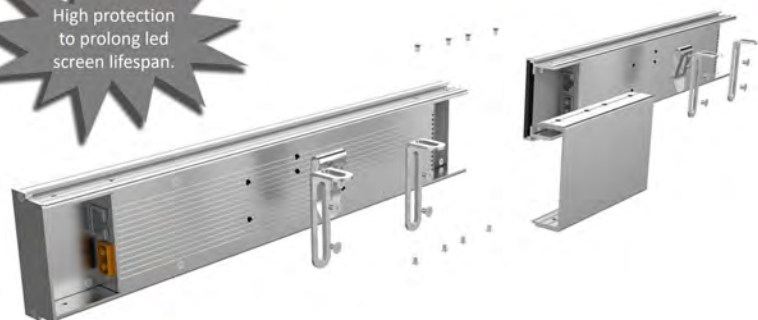

Superior Image Quality & Innovation

Over 10 years of experience, R&D, developing and manufacturing LED Display products. Black LED – High Gamma spectrum – Brilliant colours – High Refresh rate, are just a few highlights. MDS “Rental version” LED Displays contrast ratio arrive at 8000:1 and the P1.56 arrive at 10,000:1.

Global Installed base: Between 300'000 to 400'000 square meters LED Displays

Market leader

Black LEDs, GOB and COB technology, outdoor energy saving technology, MDS is one of few, offering this technology. We invest great effort and funding in R&D for new innovative products according to market demand.

Market stability & reliability

Stable and reliable raw material supply chain.

Production capacity is around 3000-4000 square meters per month.

Professional OEM and ODM ability.

Planning and advice assistance

Experienced experts plan and suggest best solution for your individual projects.

Turn Key solutions with competitive pricing structure

Complete package with spare Modules, PCB, cables, brackets and accessories

Wide product palette

Innovative indoor and outdoor solutions for virtually any dimension and application.

Superior Service

24/7 support if available - 48 Hour Reaction for replacement parts via Major global forwarders. Technicians on call, with key milestones of Installation.

Advanced

Our R&D engineers possess over 10 years of rich experience in the led display industry. MDS offers excellent and professional service and help you to realize your projects, beyond your satisfaction.

Contact: sales@MDSdisplays.com

Sales Offices in Europe, North America & Latin America.

Peter Hossfeld (ph@mdsdisplays.com)

Clive Vickery (clive.vickery@nagasoftsales.com)

Peter Connaway (peter.connaway@nagasoftsales.com)

www.MDSdisplays.com

Subject to change without notice

